

Single Switch MOSFET Power Module

$V_{DSS} = 1200V$
 $R_{DSon} = 95m\Omega \text{ typ @ } T_j = 25^\circ C$
 $I_D = 103A \text{ @ } T_c = 25^\circ C$

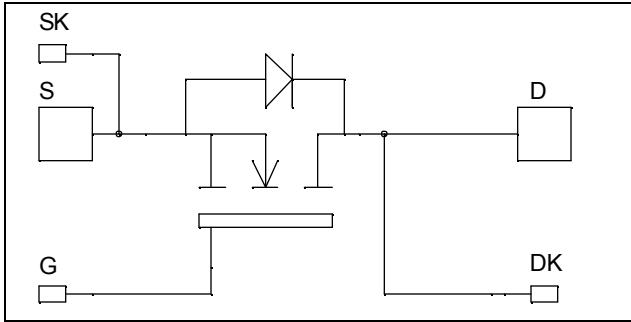

Application

- Welding converters
- Switched Mode Power Supplies
- Uninterruptible Power Supplies
- Motor control

Features

- Power MOS 7[®] FREDFETs
 - Low R_{DSon}
 - Low input and Miller capacitance
 - Low gate charge
 - Fast intrinsic reverse diode
 - Avalanche energy rated
 - Very rugged
- Kelvin source for easy drive
- Very low stray inductance
 - Symmetrical design
 - M5 power connectors
- High level of integration
- AlN substrate for improved thermal performance

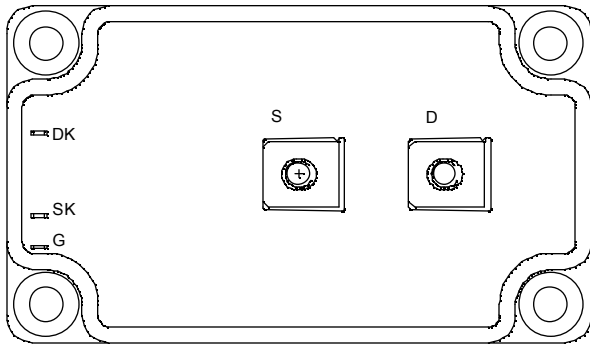

Benefits

- Outstanding performance at high frequency operation
- Direct mounting to heatsink (isolated package)
- Low junction to case thermal resistance
- Low profile
- RoHS Compliant

Absolute maximum ratings

Symbol	Parameter	Max ratings	Unit
V_{DSS}	Drain - Source Breakdown Voltage	1200	V
I_D	Continuous Drain Current	$T_c = 25^\circ C$	103
		$T_c = 80^\circ C$	77
I_{DM}	Pulsed Drain current	412	A
V_{GS}	Gate - Source Voltage	± 30	V
R_{DSon}	Drain - Source ON Resistance	114	m Ω
P_D	Maximum Power Dissipation	$T_c = 25^\circ C$	2272
I_{AR}	Avalanche current (repetitive and non repetitive)	25	A
E_{AR}	Repetitive Avalanche Energy	50	mJ
E_{AS}	Single Pulse Avalanche Energy	3000	

CAUTION: These Devices are sensitive to Electrostatic Discharge. Proper Handling Procedures Should Be Followed. See application note APT0502 on www.microsemi.com

All ratings @ $T_j = 25^\circ\text{C}$ unless otherwise specified

Electrical Characteristics

Symbol	Characteristic	Test Conditions	Min	Typ	Max	Unit
I_{DSS}	Zero Gate Voltage Drain Current	$V_{GS} = 0\text{V}, V_{DS} = 1200\text{V}$			0.6	mA
		$V_{GS} = 0\text{V}, V_{DS} = 1000\text{V}$			3	
$R_{DS(on)}$	Drain – Source on Resistance	$V_{GS} = 10\text{V}, I_D = 51.5\text{A}$		95	114	m Ω
$V_{GS(th)}$	Gate Threshold Voltage	$V_{GS} = V_{DS}, I_D = 15\text{mA}$	3		5	V
I_{GSS}	Gate – Source Leakage Current	$V_{GS} = \pm 30\text{V}, V_{DS} = 0\text{V}$			± 500	nA

Dynamic Characteristics

Symbol	Characteristic	Test Conditions	Min	Typ	Max	Unit
C_{iss}	Input Capacitance	$V_{GS} = 0\text{V}$		30.9		nF
C_{oss}	Output Capacitance	$V_{DS} = 25\text{V}$		4.6		
C_{rss}	Reverse Transfer Capacitance	$f = 1\text{MHz}$		0.78		
Q_g	Total gate Charge	$V_{GS} = 10\text{V}$		1122		nC
Q_{gs}	Gate – Source Charge	$V_{Bus} = 600\text{V}$		144		
Q_{gd}	Gate – Drain Charge	$I_D = 103\text{A}$		720		
$T_{d(on)}$	Turn-on Delay Time	Inductive switching @ 125°C		20		ns
T_r	Rise Time	$V_{GS} = 15\text{V}$		15		
$T_{d(off)}$	Turn-off Delay Time	$V_{Bus} = 800\text{V}$		160		
T_f	Fall Time	$I_D = 103\text{A}$ $R_G = 0.8\Omega$		45		
E_{on}	Turn-on Switching Energy	Inductive switching @ 25°C		5.9		mJ
E_{off}	Turn-off Switching Energy	$V_{GS} = 15\text{V}, V_{Bus} = 800\text{V}$ $I_D = 103\text{A}, R_G = 0.8\Omega$		4.1		
E_{on}	Turn-on Switching Energy	Inductive switching @ 125°C		9.4		mJ
E_{off}	Turn-off Switching Energy	$V_{GS} = 15\text{V}, V_{Bus} = 800\text{V}$ $I_D = 103\text{A}, R_G = 0.8\Omega$		5.14		

Source - Drain diode ratings and characteristics

Symbol	Characteristic	Test Conditions	Min	Typ	Max	Unit	
I_S	Continuous Source current (Body diode)	$T_c = 25^\circ\text{C}$			103	A	
		$T_c = 80^\circ\text{C}$			77		
V_{SD}	Diode Forward Voltage	$V_{GS} = 0\text{V}, I_S = -103\text{A}$			1.3	V	
dv/dt	Peak Diode Recovery ①				18	V/ns	
t_{rr}	Reverse Recovery Time	$I_S = -103\text{A}$ $V_R = 600\text{V}$ $di/dt = 600\text{A}/\mu\text{s}$	$T_j = 25^\circ\text{C}$			320	ns
			$T_j = 125^\circ\text{C}$			650	
Q_{rr}	Reverse Recovery Charge	$I_S = -103\text{A}$ $V_R = 600\text{V}$ $di/dt = 600\text{A}/\mu\text{s}$	$T_j = 25^\circ\text{C}$		12	μC	
			$T_j = 125^\circ\text{C}$		42		

 ① dv/dt numbers reflect the limitations of the circuit rather than the device itself.

$$I_S \leq -103\text{A} \quad di/dt \leq 700\text{A}/\mu\text{s} \quad V_R \leq V_{DSS} \quad T_j \leq 150^\circ\text{C}$$

Thermal and package characteristics

Symbol Characteristic

		<i>Min</i>	<i>Typ</i>	<i>Max</i>	<i>Unit</i>	
R_{thJC}	Junction to Case Thermal Resistance			0.055	°C/W	
V_{ISOL}	RMS Isolation Voltage, any terminal to case t=1 min, I _{isol} <1mA, 50/60Hz	2500			V	
T_J	Operating junction temperature range	-40		150	°C	
T_{STG}	Storage Temperature Range	-40		125		
T_C	Operating Case Temperature	-40		100		
Torque	Mounting torque	To heatsink	M6	3	5	N.m
		For terminals	M5	2	3.5	
Wt	Package Weight			280	g	

SP6 Package outline (dimensions in mm)

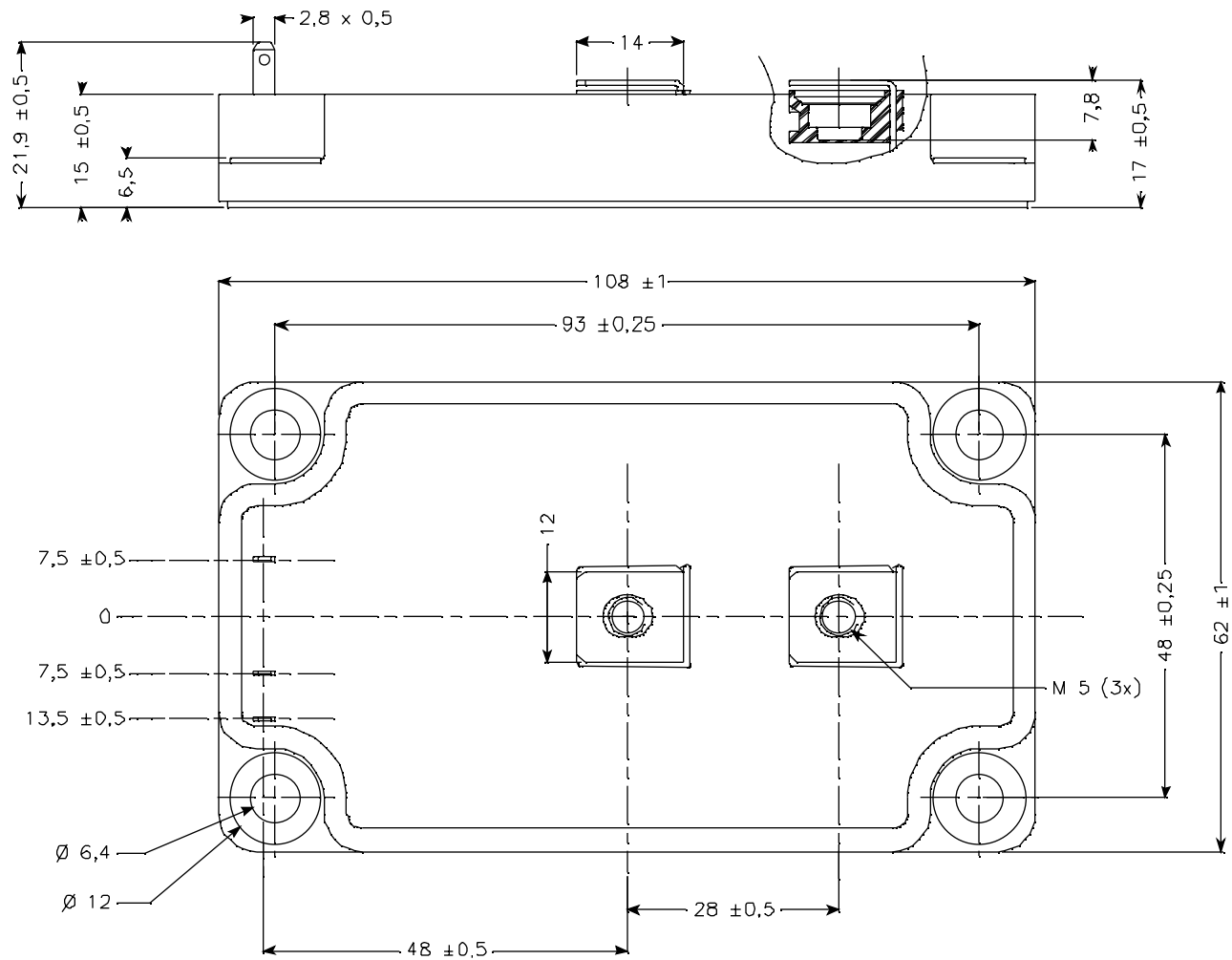

See application note APT0601 - Mounting Instructions for SP6 Power Modules on www.microsemi.com

Typical Performance Curve

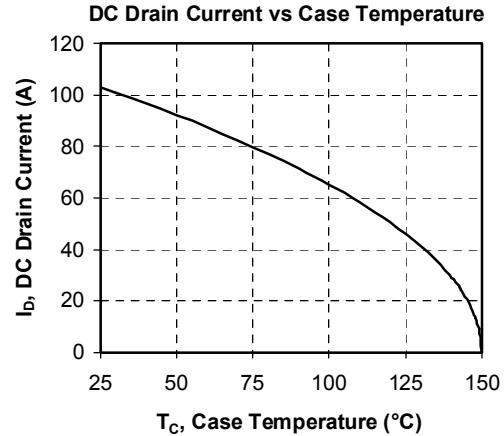
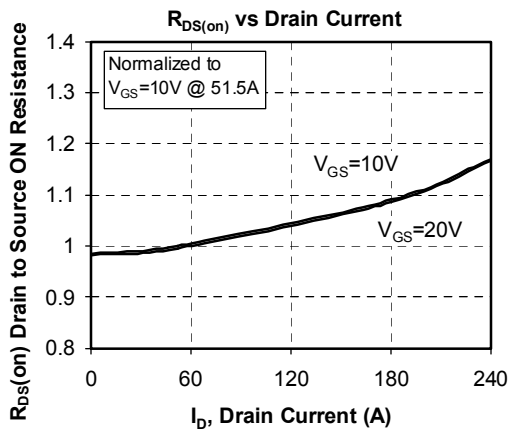
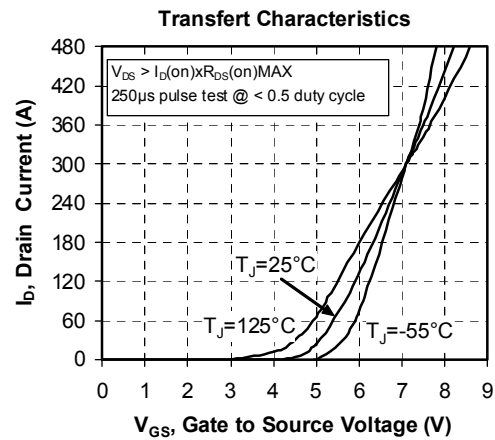
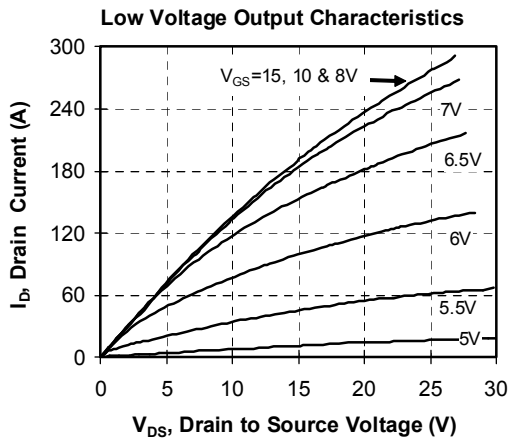
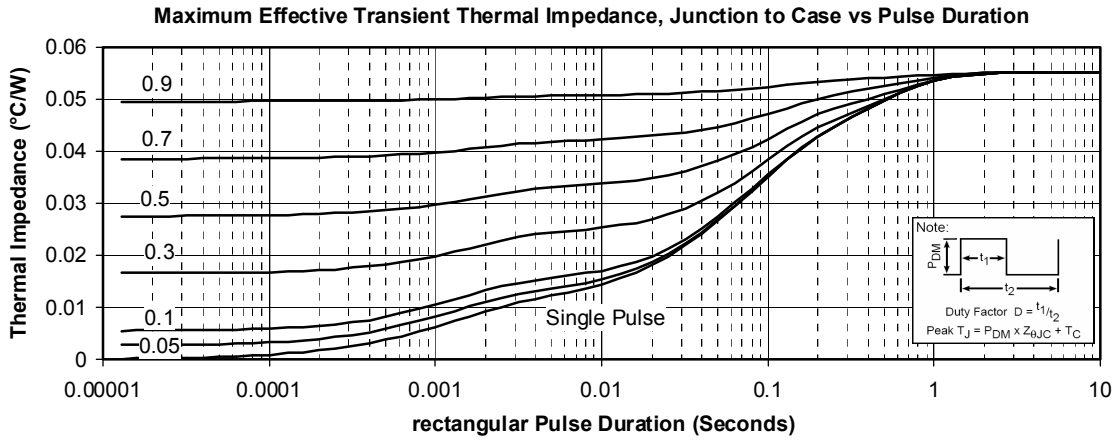

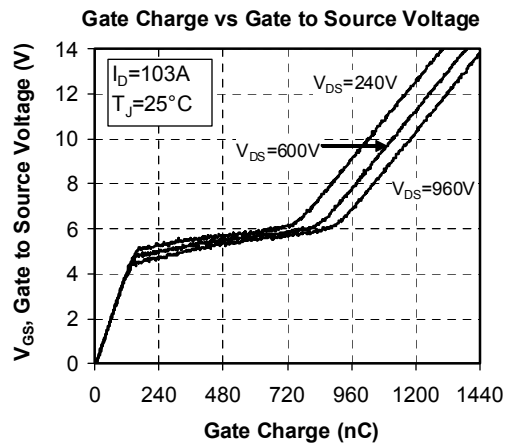
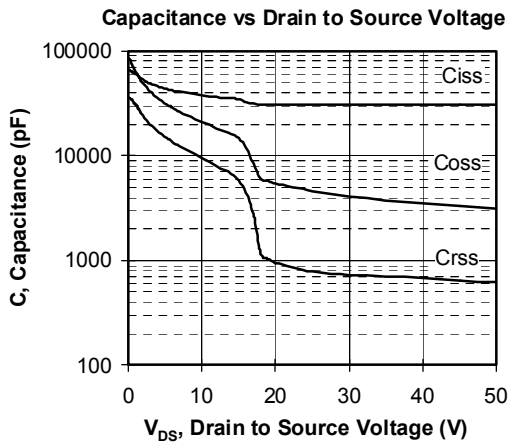
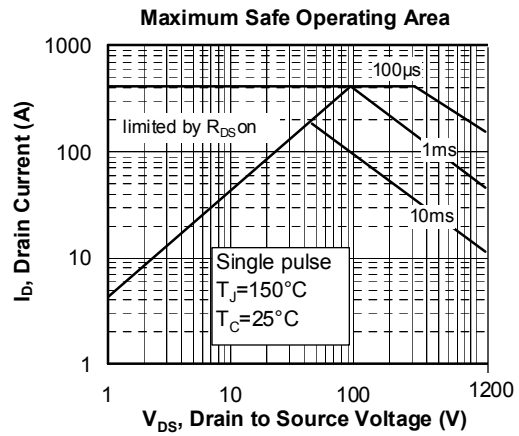
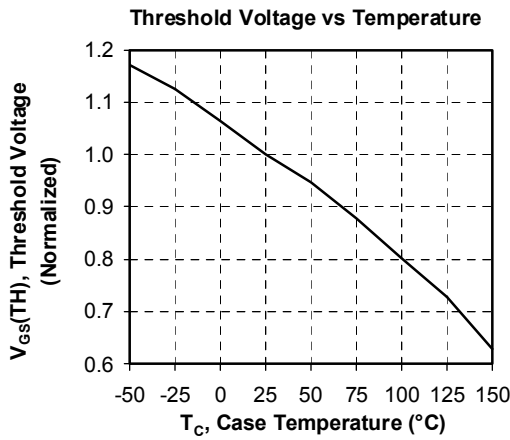
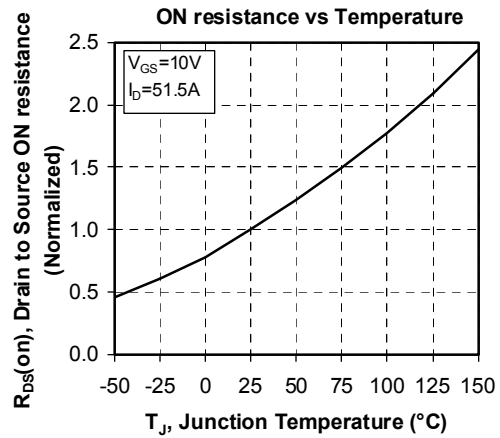
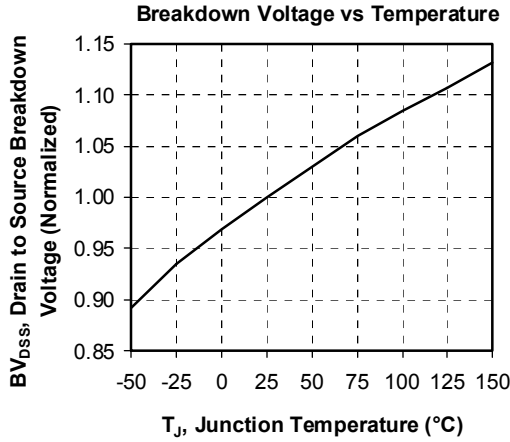

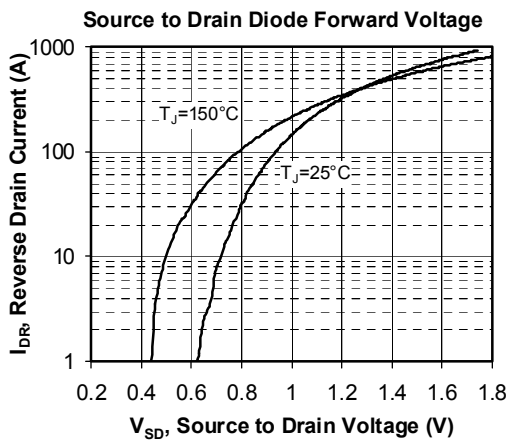
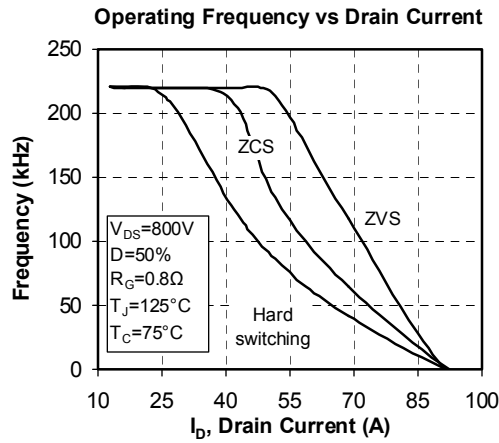
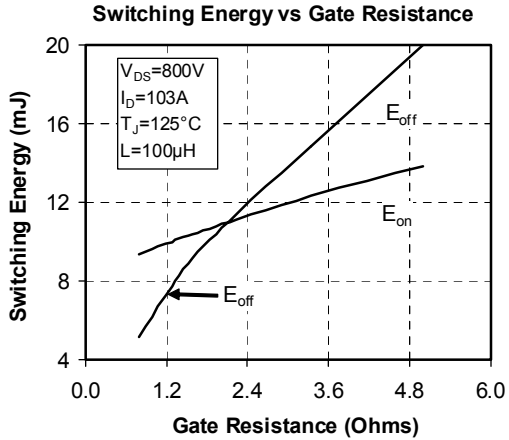
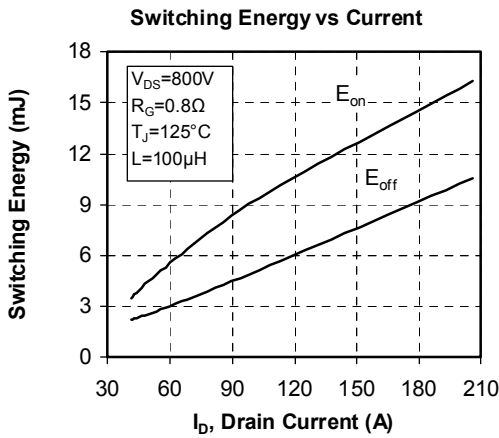
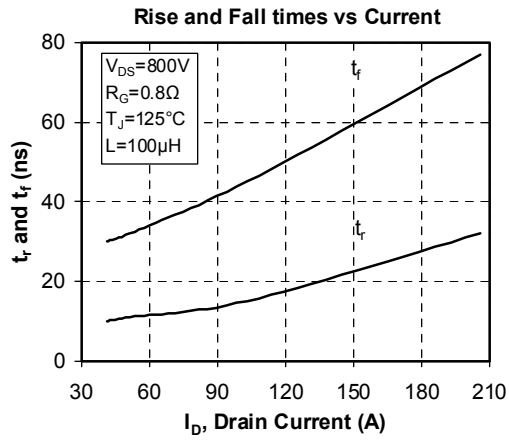
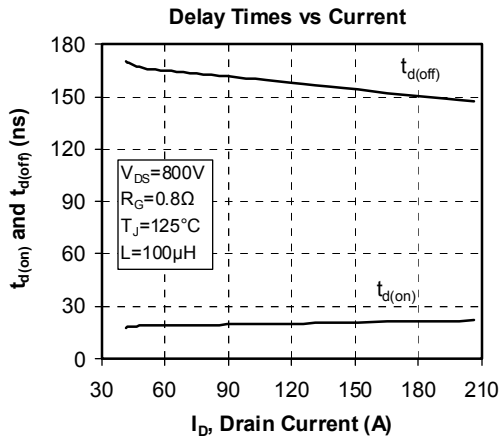

Microsemi reserves the right to change, without notice, the specifications and information contained herein

Microsemi's products are covered by one or more of U.S. patents 4,895,810 5,045,903 5,089,434 5,182,234 5,019,522 5,262,336 6,503,786 5,256,583 4,748,103 5,283,202 5,231,474 5,434,095 5,528,058 and foreign patents. U.S. and Foreign patents pending. All Rights Reserved.